

# Speaker build – preliminary

- There are many kinds of speakers we could try to build. In keeping with the principle of “Start simple, work towards bigger”, I propose a set of bookshelf (desktop) speakers.
- The “Overnight sensations” by Paul Carmody are a great set of speakers that are relatively easy to build. Carmody designed these in 2008 and probably thousands have been made by enthusiasts over the years. ( <https://sites.google.com/site/undefinition/bookshelf-speakers/diy-overnightsensations> )
- Carmody specifies components from Parts-Express. In fact, Parts-Express offers complete kit that have almost everything, including the wood. ( Parts-express: <http://www.parts-express.com/overnight-sensations-mt-speaker-kit-pair--300-706>. Usual price is \$160.)
- We can probably save a few bucks by buying parts a la cart and cutting a corner or two.



# A few details

- The speakers are of the “midrange - tweeter” (M-T) variety.
- The mid-range is the 4-inch HiVi B4N.
- The tweeter is the 3/4-inch Dayton ND20FA-6.
- The volume of the box is about 4.5 liters.
- The box is ported. The port tube is tuned for a resonance of 53 Hz.
- The cross-over network is relatively simple, a third-order high-pass with a “pad” for the tweeter and a third-order low-pass for the mid-range. (More on that below.)
- The enclosure can be made easily using medium-density fiber (MDF) board, although there are lot of options.
- Also need connectors and a few other random pieces. (Not included in the kit described on the previous page.)

# Everything needed to build two speakers

- 2 midranges.
- 2 tweeters.
- 2 adjustable port tubes.
- 2 sets of binding posts.
- 2 large inductors (1.0 or 1.1 mH)
- 2 small inductors (0.33 mH or 0.35 mH)
- 2 6.8- $\mu$ F capacitors.
- 2 2.2- $\mu$ F capacitors.
- 2 1.5- $\mu$ F capacitors.
- 2 0.22- $\mu$ F capacitors.
- 2 10- $\Omega$  resistors (10 W).
- 2 6- $\Omega$  resistors (10 W).
- 2 perfboards, sized for either small or large components.
- 4 side panels.
- 4 top/bottom panels.
- 2 front panels, with holes drilled.
- 2 back panels, with holes drilled.
- About three feet of speaker wire (18 gauge or bigger is fine).
- 16 or 24 screws — #6 x 3/4 inch. (24 if the back will be screwed on.)

# Tools and miscellaneous items

Essential:

- Wood glue.
- Clamps or some other means of applying pressure to the wood panels while the glue dries. (For example, a stack of heavy books or a sleeping roommate.)
- Soldering iron and solder.

A hot glue gun is handy, but not essential. Epoxy glue would also work.

If you want to do a nicer job of finishing the exterior:

- Sandpaper — 60 to 100 grit should be fine. If you have power sander or oscillating tool, the smoothing job will go much faster.
- Wood filler.
- Paint (primer and top coat)
- Paint brush or roller.

# Drivers, port tubes, binding posts

## Parts Express

Qty	Part Number	Description	cost each
2	297-429	HiVi B4N 4" Aluminum Midbass Round Frame	\$17.40
2	275-030	Dayton Audio ND20FA-6 3/4" Neodymium Dome Tweeter	\$9.49
2	260-388	Port Tube 1-3/8" ID Adjustable	\$2.76
1	091-1250	set of 4 binding posts	\$15.98
			<b>\$75.28</b>



mid-range



tweeter



port tube



binding posts

# HiVi B4N

Specs from Parts Express web page.

## Product Details

Brand	HiVi
Model	B4N
Part Number	297-429
UPC	844632024979
Unit of Measure	Each
Weight	2

## Product Specifications

Nominal Diameter	4"
Power Handling (RMS)	25 Watts
Power Handling (MAX)	50 Watts
Impedance	8Ω
Frequency Response	60 to 4,000Hz
Sensitivity	85dB 2.83V/1m
Voice Coil Diameter	1"

## Thiele-Small Parameters

Resonant Frequency (Fs)	56Hz
DC Resistance (Re)	6.5Ω
Mechanical Q (Qms)	3.91
Electromagnetic Q (Qes)	0.63
Total Q (Qts)	0.52
Compliance Equivalent Volume (Vas)	0.16ft <sup>3</sup>
Mechanical Compliance of Suspension (Cms)	1.11mm/N
BL Product (BL)	5.1T·m
Diaphragm Mass Inc. Airload (Mms)	6.8g
Maximum Linear Excursion (Xmax)	3.2mm
Surface Area of Cone (Sd)	53cm <sup>2</sup>

## Materials of Construction

Cone Material	Aluminum / Magnesium
Voice Coil Former	Kapton® / Polyimide
Magnet Material	Ferrite

## Mounting Information

Overall Outside Diameter	4.59"
Baffle Cutout Diameter	3.66"
Depth	2.85"
# Mounting Holes	4

## Parts Express Staff Recommended Enclosure Volume

Sealed Volume	0.15ft <sup>3</sup>
Sealed F3	85.2Hz
Vented Volume	0.3ft <sup>3</sup>
Vented F3	46.4Hz

# Dayton ND20FA-6

Specs from Parts Express web page.

## Product Details

Brand	Dayton Audio
Model	ND20FA-6
Part Number	275-030
UPC	844632000874
Unit of Measure	Each
Weight	0.1

## Product Specifications

Cone / Dome Diameter	0.75"
Cutout Diameter	1.30
Tweeter Type	Soft Dome
Power Handling (RMS)	15 Watts
Impedance	6Ω
Frequency Response	3,500 to 25,000Hz
Sensitivity	90dB 2.83V/1m

## Thiele-Small Parameters

Resonant Frequency (Fs)	2005Hz
DC Resistance (Re)	5.2Ω
Voice Coil Inductance (Le)	0.05mH
Mechanical Q (Qms)	1.5
Electromagnetic Q (Qes)	2.88
Total Q (Qts)	0.99

## Mounting Information

Overall Outside Diameter	1.77"
Depth	0.59"

# Cross-over network

Here is the cross-over network as designed by Carmody.

The upper section is a “3rd-order high-pass” circuit with a voltage divider “pad”. This sends the higher-frequency components of the sound to the tweeter.

The lower section is a “3rd-order low-pass” circuit that sends the lower frequencies to the mid-range.

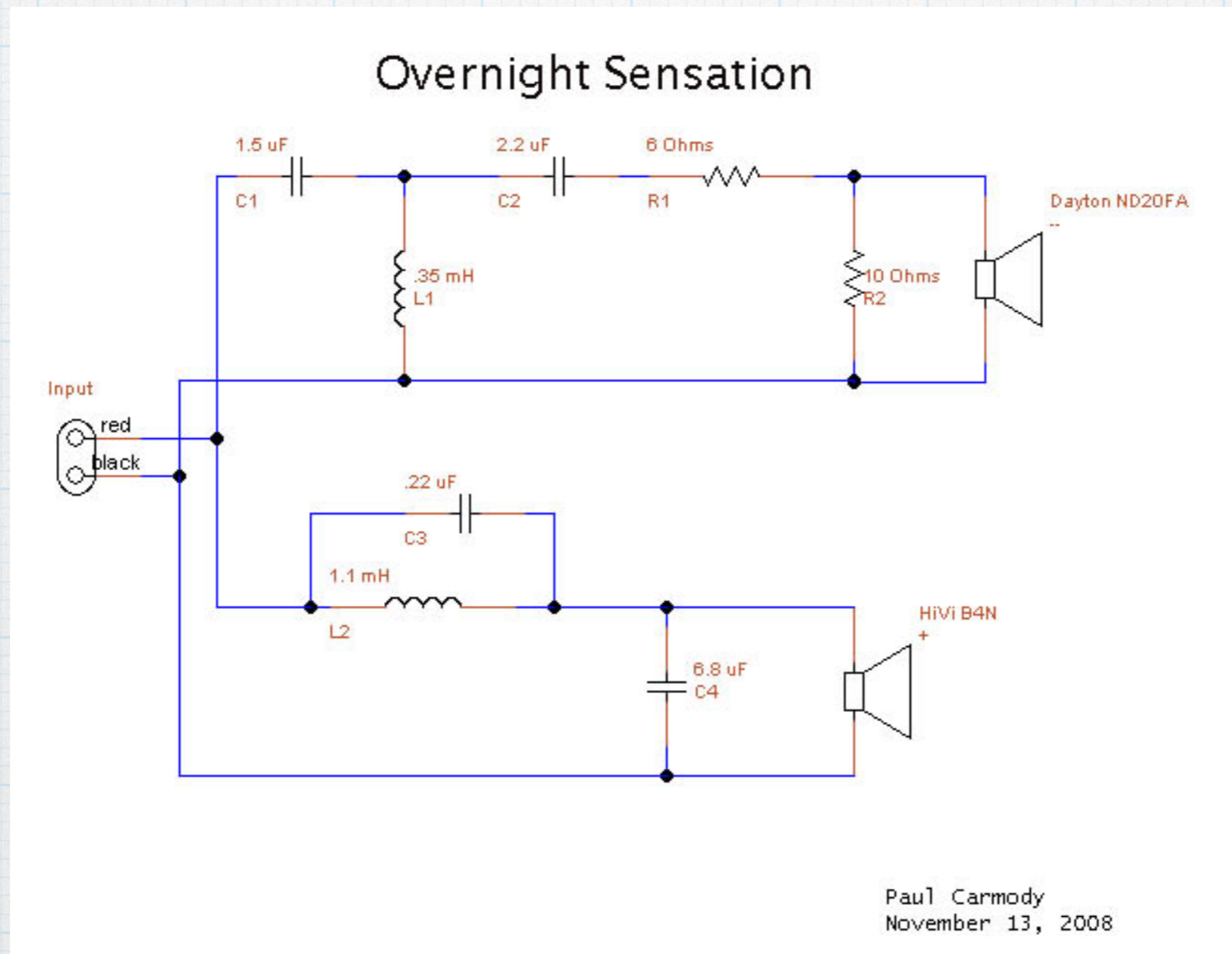



# Cross-over simulation

LTspice

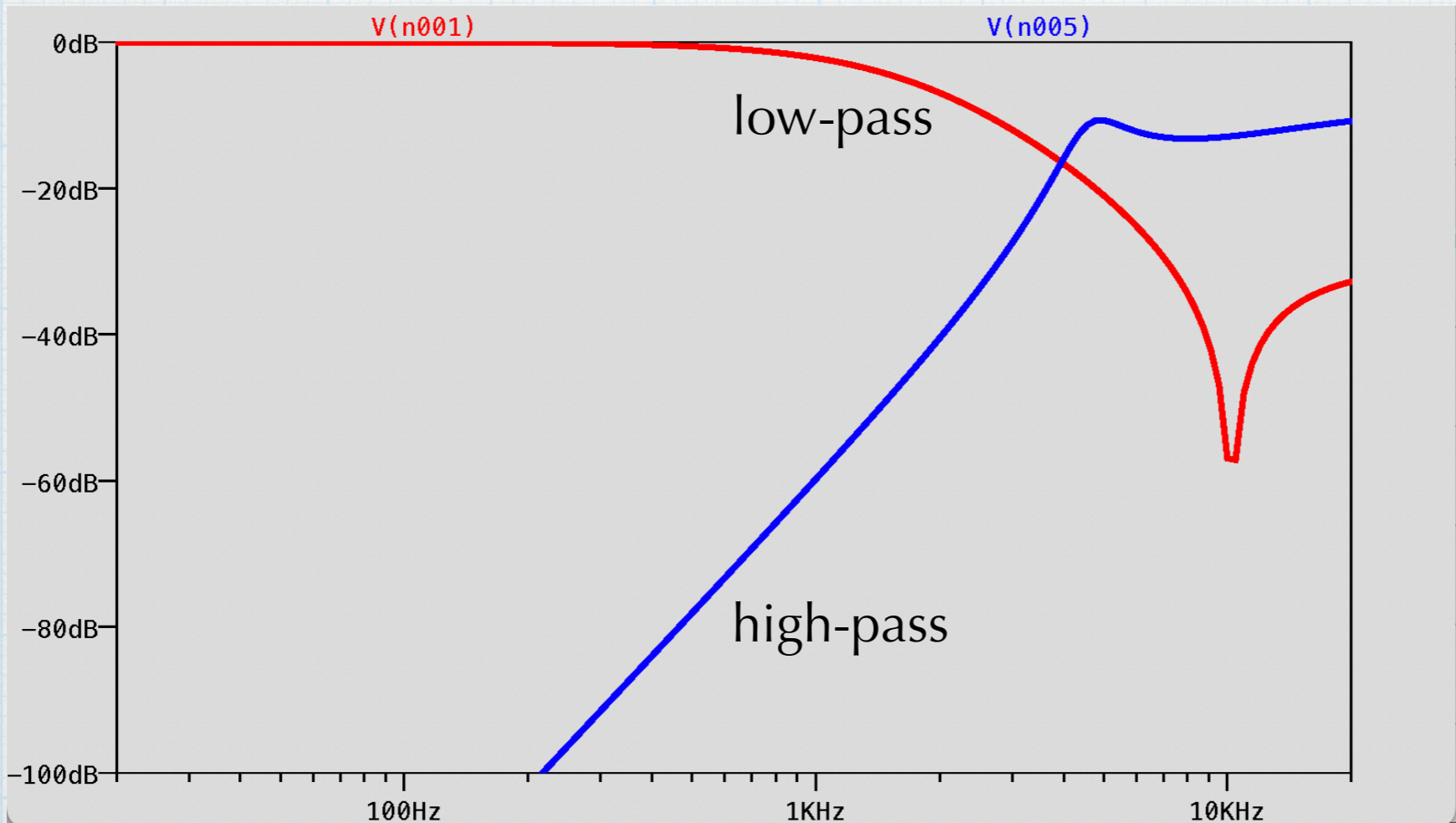
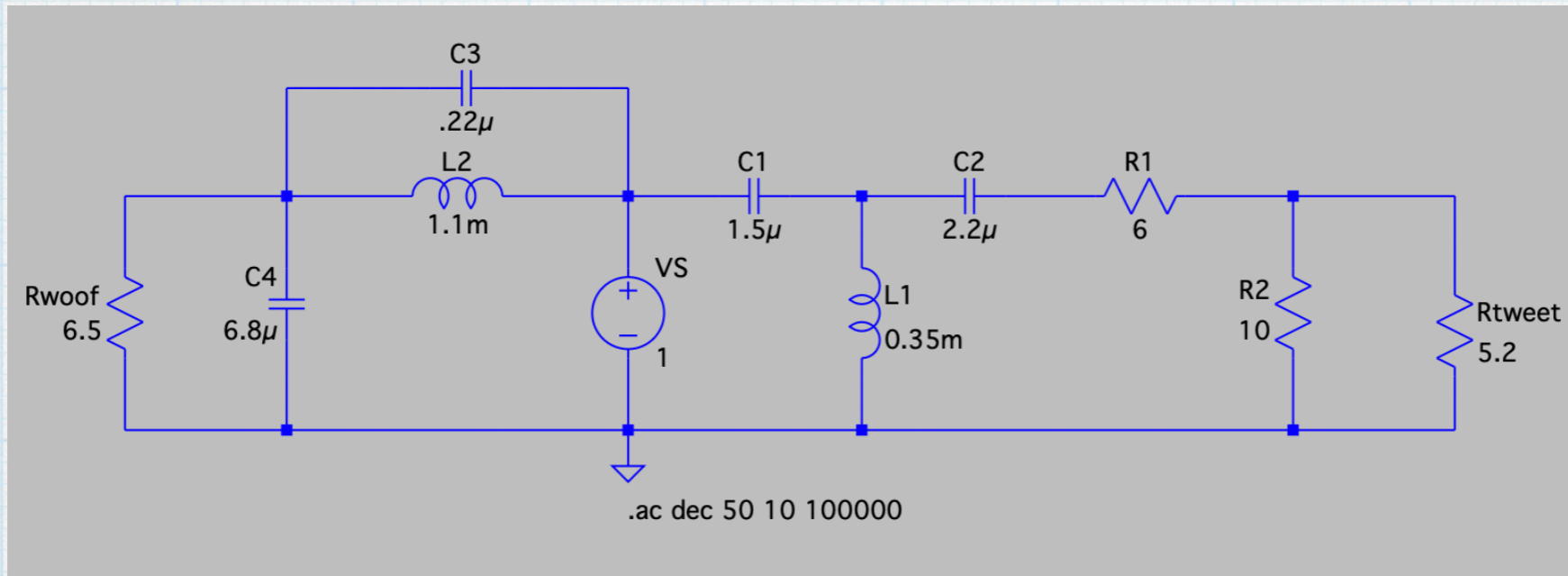

# Cross-over component options

The cross-over components specified by Carmody are typical “audiophile” components — the capacitors are made with polymer-film dielectrics and the inductors are “air-core” coils. These components are much larger and considerably more expensive than “typical” capacitors and inductors.

The most common capacitor type is a multi-layer ceramic capacitor (MLCC), which uses a high-permittivity material for the dielectric. The relative permittivities of the dielectric materials in MLCCs range from around 200 to over 10,000. This compares to the relative permittivity of polymers, which is usually measured in single digits. These MLCCs can be significantly smaller than poly capacitors.

However, a down-side of high-dielectric materials is that the permittivity is somewhat voltage dependent, meaning the capacitance will change as the voltage across the capacitor changes. This is obviously not a good thing, and will cause distortion in the signal. Polymer capacitors do not have this problem.

So there is a trade-off: use smaller, cheaper MLCCs which may introduce some distortion into the audio signal or use polymer capacitors, which are larger and more expensive, but have no distortion issues.

# Cross-over component options

There is a similar story with the inductors. Most inductors use a “core” material that has a higher magnetic permeability than air. The core enhances the magnetic field induced by the coil, allowing for an inductor that has fewer turns of wire in the core, reducing the overall size and lowering the cost. Most common inductors use a ferrite (iron-oxide based) core, and the relative permeabilities can range from around 50 to a few thousand. (The relative permeability of air is 1.)

However, like MLCCs, ferrite-core inductors come with trade-offs. First, the core material will exhibit “hysteresis” meaning the induced field does not track the same when the current is increasing versus when it is decreasing. This leads to distortion and energy loss. Also, with a core, the magnetic field can “saturate”, meaning that there is an upper limit on the value of the induced field. The inductor voltage does not change if the current is driven beyond the saturation level. This will also cause distortion — similar to supply-voltage clipping in an op-amp circuit. Ultimately, the inductor must be kept below the saturation level to avoid distortion. Air-core inductors do not have these problems, since there is no core.

So again the trade-off is to use ferrite-core inductors, which are smaller and cheaper but may induce distortion in some cases or to use larger, more expensive air-core inductors with the worry of distortion.

Carmody being an audiophile (maximum fidelity, money is no object) specified poly capacitors and air-core inductors. However, we can consider a cheaper alternative.

# Cross-over components ala Carmody

## Mostly from Parts-Express

Qty	Vendor number	Description	cost each
2	Parts Express 255-252	1.1-mH inductor, air core, 0.57 $\Omega$ (Jantzen 000-1078)	12.18
2	Parts Express 257-030	0.35-mH inductor, air-core, 0.4 $\Omega$ (Dayton AC20-35)	3.89
2	Parts Express 027-424	6.8- $\mu$ F capacitor, poly (Dayton DMPC-6.8)	1.89
2	Parts Express 027-415	2.2- $\mu$ F capacitor, poly (Dayton DMPC-2.2)	1.89
2	Parts Express 027-412	1.5- $\mu$ F capacitor, poly (Dayton DMPC-1.5)	0.69
2	Parts Express 027-402	0.22- $\mu$ F capacitor, poly (Dayton DMPC-0.22)	0.49
2	Parts Express 004-10	10- $\Omega$ resistor, 10 W (Dayton DNR-10)	0.99
2	Parts Express 004-6	6- $\Omega$ resistor, 10 W (Dayton DNR-6.0)	0.99
2	Digikey 277-1667-ND	2-position terminal block (Phoenix 1935161)	0.55
2	Digikey 2771578-ND	2-position terminal block (Phoenix 1935174)	0.77
		total (for two speakers)	<b>48.66</b>

# Economy cross-over parts

## Digikey and/or Mouser

Qty	supplier number	Description	cost each
2	Mouser 580-1410516C*	Murata 1 mH (0.46 $\Omega$ )	2.27
2	Digikey 811-1314-ND	Murata 330 $\mu$ H (0.35 $\Omega$ )	1.42
2	Digikey 445-180434-1-ND	TDK ceramic 6.8 $\mu$ F	0.87
2	Digikey 445-173138-1-ND	TDK ceramic 2.2 $\mu$ F	0.52
2	Digikey 445-180637-1-ND	TDK ceramic 1.5 $\mu$ F	0.63
2	Digikey 445-173377-1-ND	TDK ceramic 0.22 $\mu$ F	0.26
2	Digikey 10W-10-ND	Yageo 10- $\Omega$ , 10 W	1.32
2	Digikey 6.2W-10-ND	Yageo 6.2- $\Omega$ , 10 W	0.82
2	Digikey 277-1667-ND	2-position terminal block (Phoenix 1935161)	0.55
2	Digikey 2771578-ND	2-position terminal block (Phoenix 1935174)	0.77
		total (for two speakers)	<b>18.86</b>

So, we could save about \$30 by not using “audio-grade” components. The risk is in possibly having some distortion due to ceramic capacitor non-idealities and inductor-core saturation at higher currents.

\* Feb. 2025. Digikey is OUT of the 1 mH inductors (Murata 1410516C). However, Mouser has a good selection of the 1410516C inductors at the same price. I would advise ordering there.

Here are top and bottom views of the crossover using the larger components.

It is probably a good idea to glue the large inductors to the board to ensure that they don't "unspool" and come off the board. (I used a hot-glue gun to apply a few dabs of glue to each inductor.)

Again, note that the inductor coils are orthogonal to each other, to minimize mutual inductance effects.

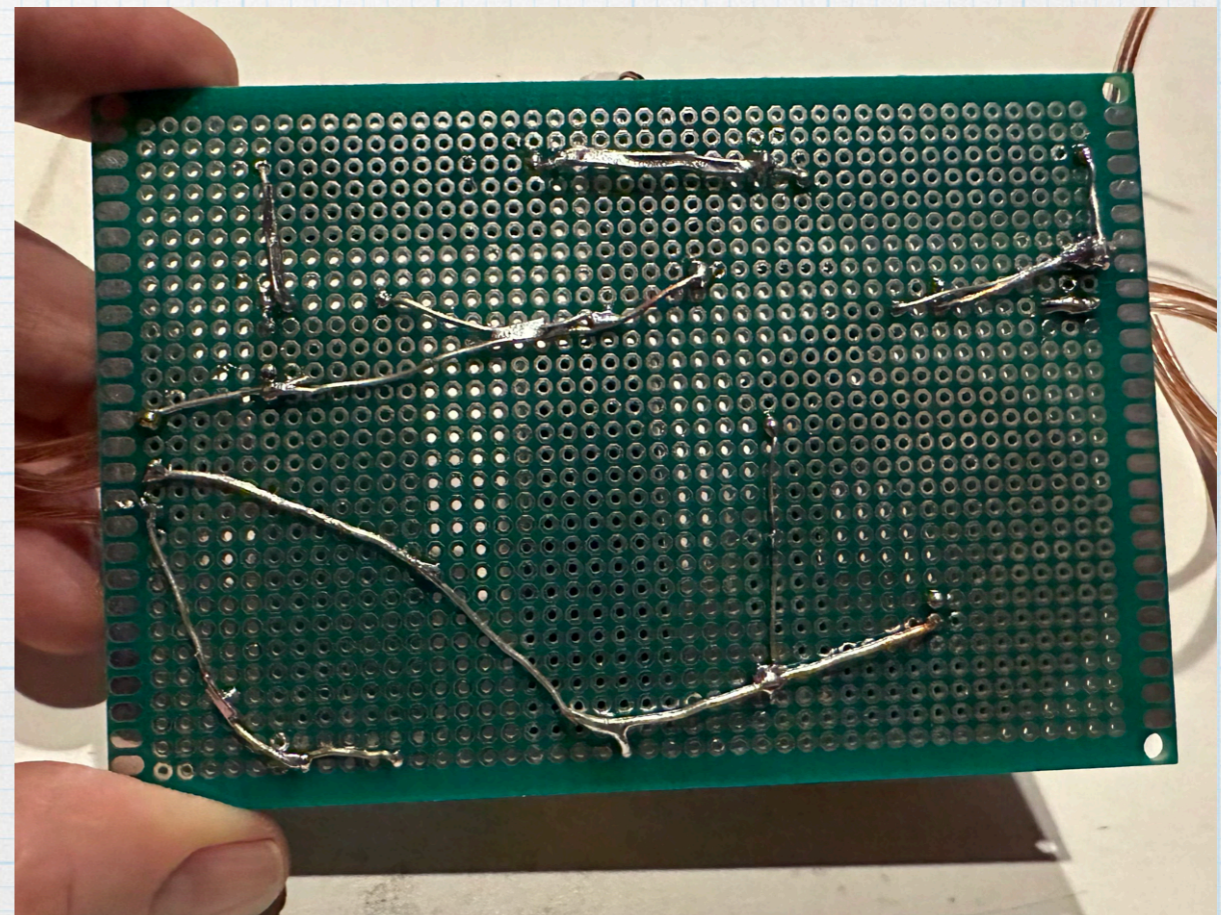
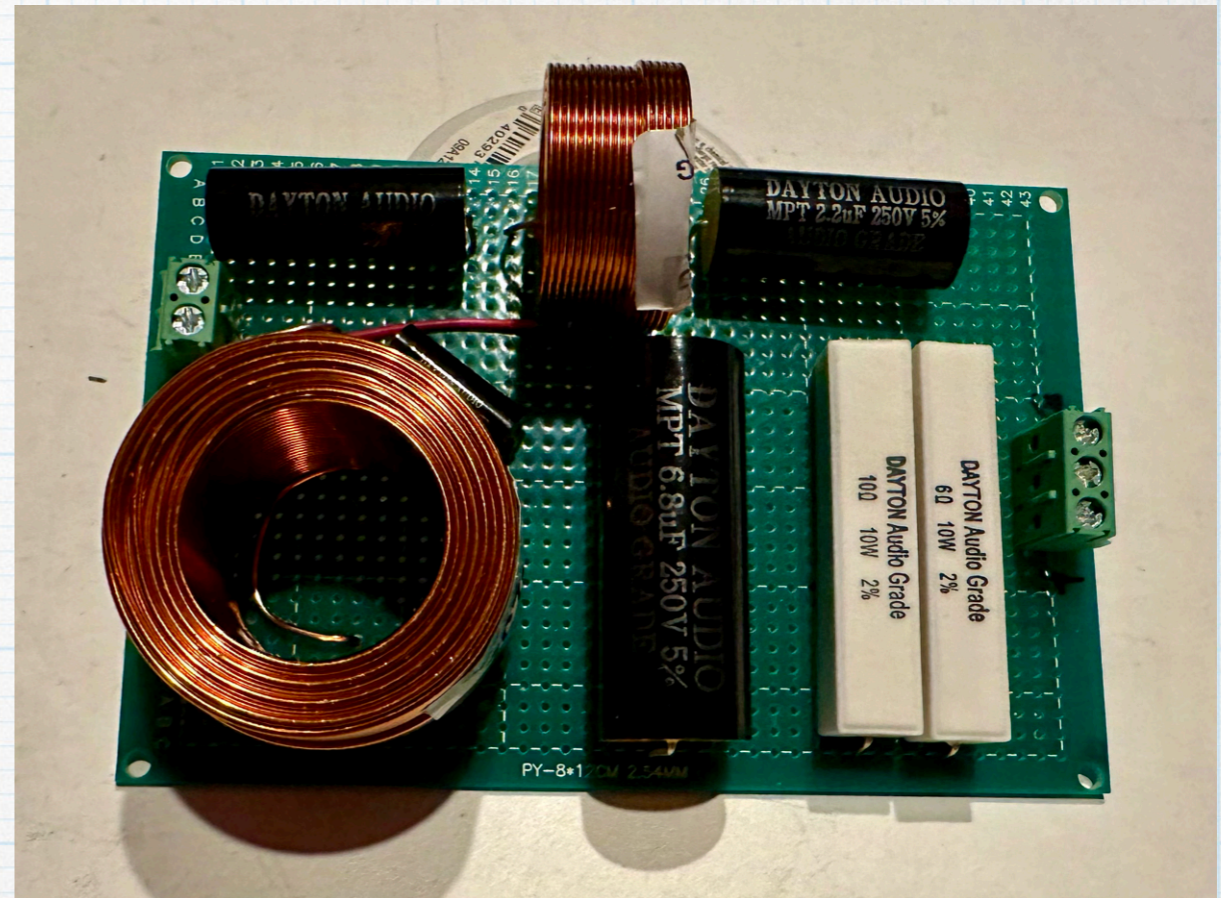

Putting all components one side is not a rigorous requirement.

In this version, the two big resistors are placed on the “wiring” side of the board, leaving a more room to space the other parts on the “component” side.

The bottom-side resistors serve as good mounting surfaces to glue the circuits to the inner surface of the enclosures.

Note that, in this case, a few extra lengths of jumper wire were used.

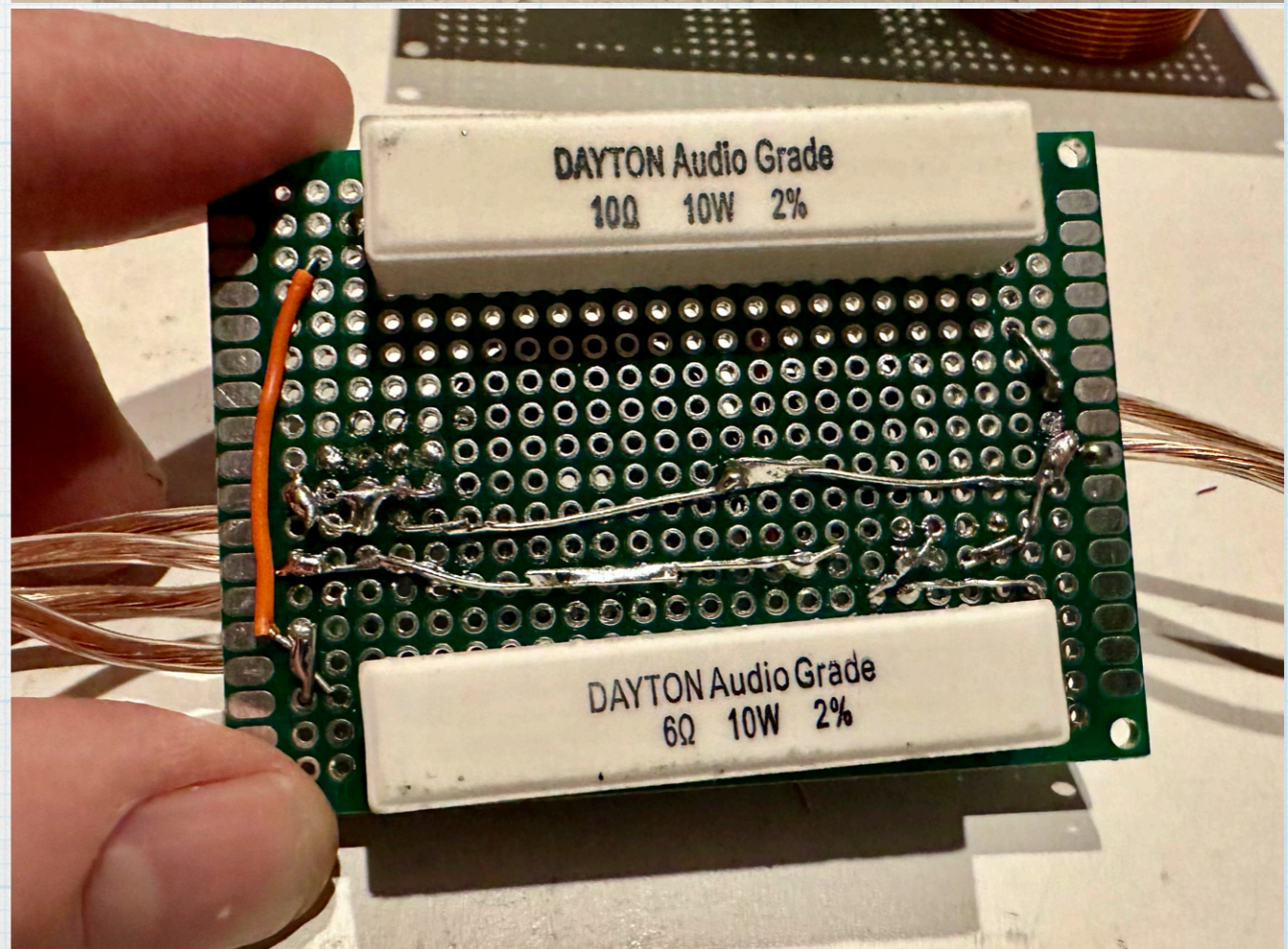
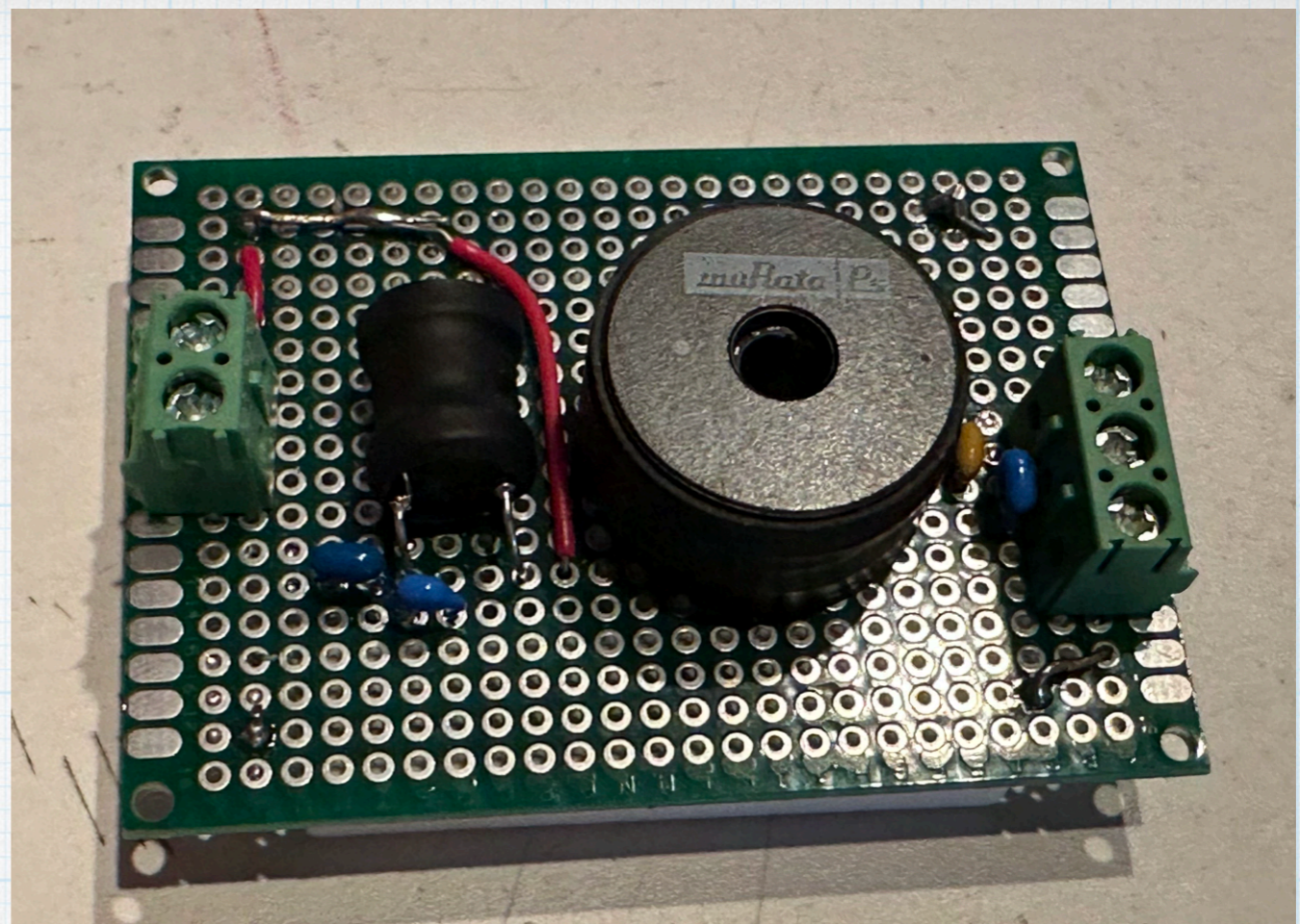

# Compare

Before final assembly, it is a good idea to test the operation of the cross-overs.

Below are frequency response plots of both sections (low-pass and high-pass) of each crossover — Carmody component and economy component.

The two frequency responses are nearly identical. However, these do not tell us anything about distortion. We would need to do different tests to measure that.

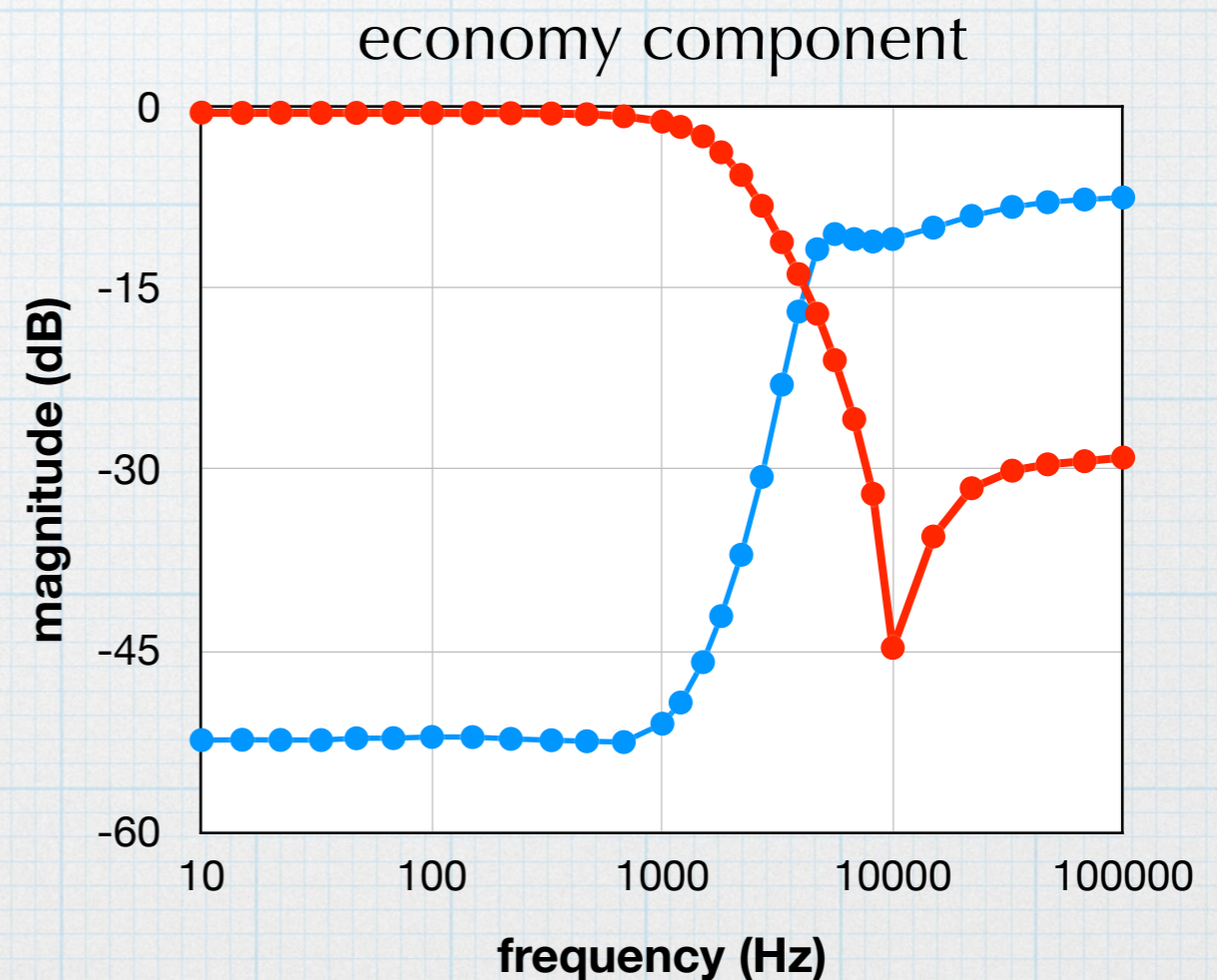
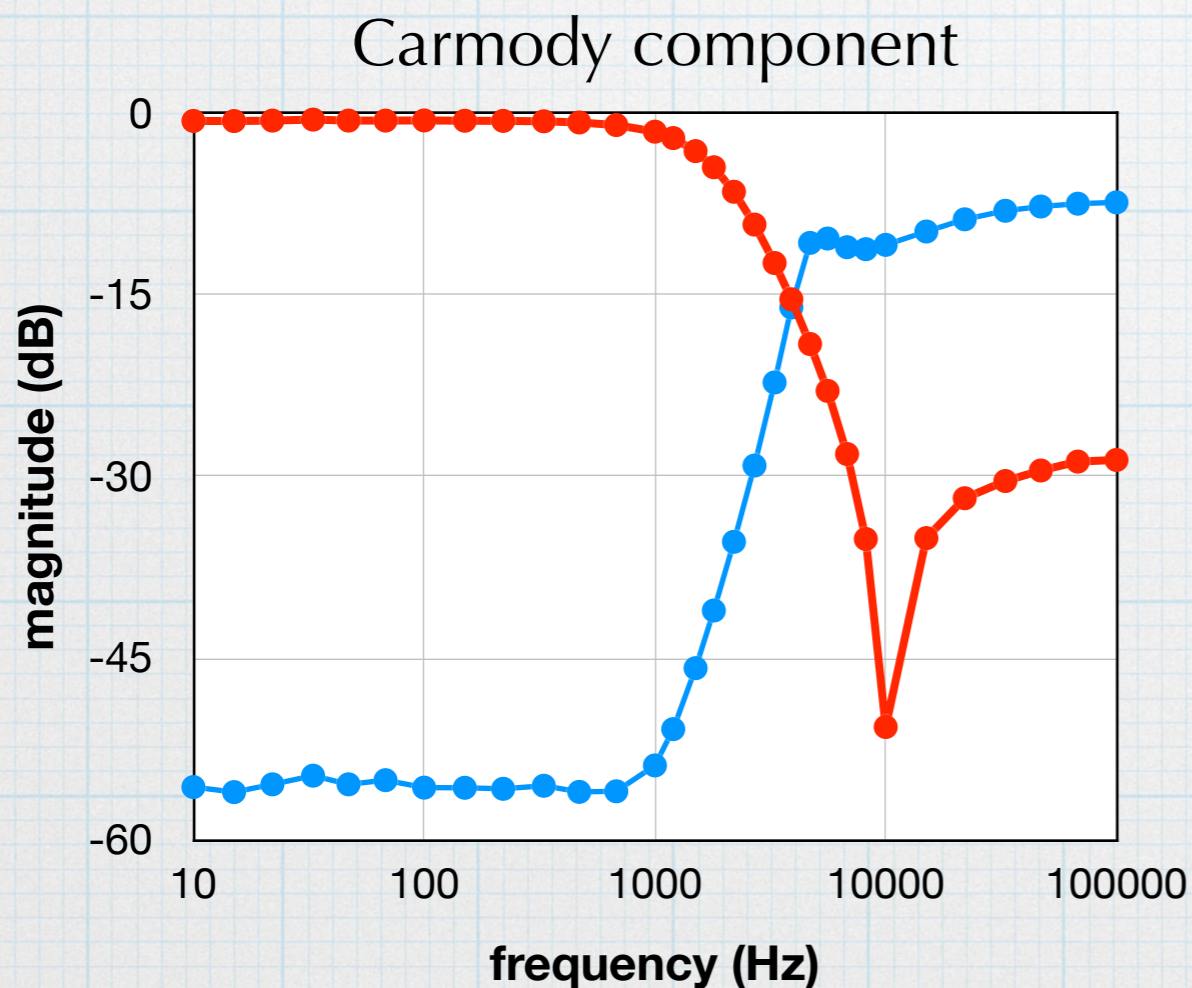



# Miscellaneous

- Two PCBs for the cross-over circuits. (In the past we have used perf board, but this time we will have designed PCBs to make the job easier.) Two PCBs will be about \$5.00
- Wood for the enclosure. We will use medium-density fiber board. The cost is about \$7.50 per set of 2 speakers. (GT will cut the panels and drill the holes for everyone.)
- Screws, wood glue, and some speaker wire. Estimate another \$5.00 for these.

## Total cost

- For the Cadillac version using Carmody components:  $\approx$  \$142.50.  
This is somewhat less than buying the full kit from Parts-Express, but not a lot. If we want audio-grade parts throughout, buying the P-E kit is a reasonable option. (But keep in mind that the binding posts, screws, and other incidentals are not included in the P-E kit.)
- For the economy version:  $\approx$  \$113.00